



warm, secure and beautiful

warmcore[®]
FOLDING SLIDING DOORS



warmcore[®]

FOLDING SLIDING DOORS

Built around a belief that beauty doesn't have to compromise performance, WarmCore aluminium folding sliding doors were created out of a desire to combine the desirability and durability of aluminium with unparalleled insulation. The orange thermal core - hidden away in the finished doors - is key to why WarmCore doors are 25% more thermally efficient than traditional aluminium systems.

BUILT WITH A REVOLUTIONARY THERMAL CORE AT ITS HEART

Strong and secure, WarmCore doors come with class leading security built in, backed by a comprehensive 10 year product guarantee, reinforced by the ERA Five Star security guarantee. Inwards or outwards opening doors up to 6m wide, with as many as 7 opening sashes glide along custom designed tracks. While a wealth of colour, style and configuration options help you choose the perfect warm, secure and beautiful WarmCore door for your home.

**THE BEAUTIFUL, STRONG AND SECURE
DOOR THAT IS 25% MORE THERMALLY
EFFICIENT THAN THE COMPETITION**

WARMCORE, THE WARMER CHOICE THAT SAVES YOU MONEY

The traditional weakness of aluminium doors has been the aluminium itself. While a beautifully strong and hard-wearing material, aluminium is a good conductor of energy. Meaning that the warmth from your home finds an easy path outside, leaving you colder and with higher heating bills. Most aluminium folding sliding doors try to overcome this inherent weakness by replacing a section of aluminium with a small thermal break of less conductive material to lessen this heat loss.

WarmCore took a different approach, from inception this revolutionary folding sliding door was designed to be as thermally efficient as possible. Built around a full width thermal core - maximising the use of low conductive material - WarmCore is 25% more efficient at keeping heat in your home than traditional aluminium doors. Yet it doesn't compromise strength as the outer faces of the profile are high grade aluminium, positioned to add the greatest structural rigidity.

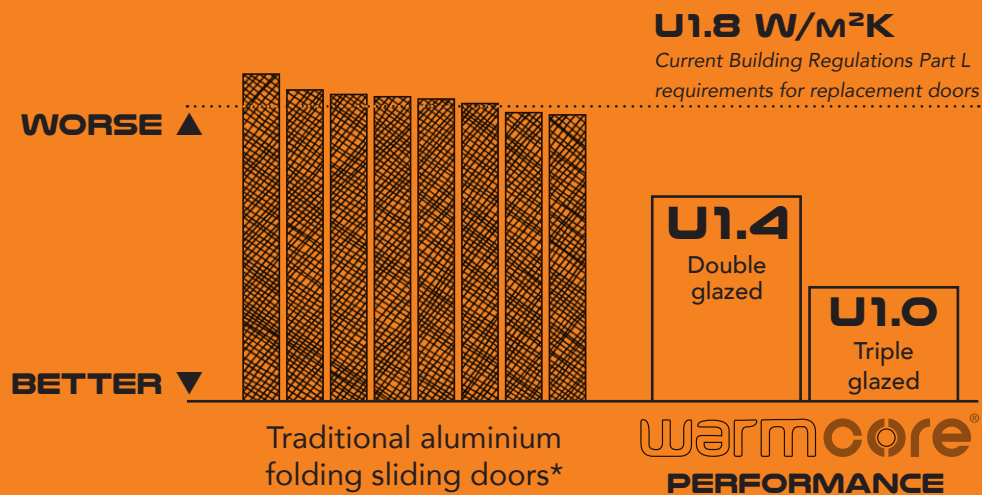

U-VALUES EXPLAINED

A U-Value is basically a measure of heat loss through a structural element. It is calculated on the rate at which heat transfers through 1 square metre of a structure and is stated in W/m²K. U-Values are used by the construction industry to compare the thermal performance of different materials and products.

* Data correct at time of publication. Based on nine UK aluminium double glazed folding sliding doors with the following U-Values: 1.94, 1.87, 1.85, 1.84, 1.83, 1.83, 1.81, 1.77, 1.76

WARMER BY DESIGN

WarmCore has been designed from the ground up to offer market-leading thermal performance, and comfortably meets the requirements of Building Regulations - Part L. Traditional aluminium doors struggle to meet current legislation, forcing you to choose aluminium aesthetics and finish over thermal performance. WarmCore gives you both, with its innovative full width thermal core.

This unique composite construction creates the most thermally efficient folding sliding door in its class. This design philosophy has produced a folding sliding door that has exceptional thermal performance, helping keep fuel bills lower and heat in your home, while retaining the sleek and architectural look of aluminium.



WARM, WIDE SPAN DOORS FOR MODERN LIVING

.....



HELPING TRANSFORM YOUR LIVING SPACE

Modern living is about creating spaces that work for you and your family, that adapt to the needs of the moment. Gone are the days of rigidly defined spaces. WarmCore folding sliding doors were born from this ethos, and their flexibility helps your home become a space that works for you. Open and airy on beautiful summer days, warm and insulating in the colder months. WarmCore doors help integrate outside living space with interiors, enhancing both.

Truly transformative, WarmCore doors will help breathe life and light into your home.



STYLISH INTERIORS, BROUGHT TO LIFE

.....



PRACTICAL FOR EVERYDAY USE

The innovative design of WarmCore folding sliding doors enables you to split the door sashes in whichever way suits your home. You can have all the sashes fold to the right or left, or have them split in any combination you choose.

A popular configuration is to have a single door at one end, called a traffic door.

This allows you to leave the majority of the door sashes locked in place, using a single door for everyday use.

In addition certain door configurations offer even more practicality, as the door sashes that meet in the middle, or at one end, can be used as a set of French doors - when you don't need, or want, the doors fully open.

This flexibility enables you to use your WarmCore folding sliding doors in a way that suits you, rather than being forced to fully open them every time. Leave that until you're entertaining or when the day is so good it deserves to be let in.



FLEXIBILITY BUILT-IN



PERFECT ALIGNMENT

Whether you are tucked up inside watching TV with your WarmCore folding sliding doors protecting you from the elements, or hosting a garden party with the doors wide open on a bright spring day, you can be assured your doors will look pristine.

Attention has been paid to how the doors look when stacked open, something often overlooked on traditional door systems. When open, all sashes stack neatly in line with each other and are kept perfectly parallel using discreet magnets.

Open ends of door sashes, hidden from view when the door is closed, are also carefully cloaked in uniform black for a neat and thought-through appearance.



BEAUTIFUL AESTHETICS

.....





STRONG CONSTRUCTION BUILT FOR UNPARALLELLED SECURITY

From the unique 5 point lock, designed to run the full length of the door sash, to the high strength hinges and rollers; each element of the WarmCore door combines to ensure optimum security.

WarmCore's aluminium construction, custom-made roller assemblies - sitting deep within the top and bottom tracks - and extruded aluminium hinges make them inherently strong and secure. Added security features such as integral dog bolts bind the door sashes together when closed, protecting against forced entry.

A custom designed door lock, available on no other door system, uses a 5 point locking system with 3 opposed hook locks and twin shoot bolts - that engage fully into the aluminium top and bottom tracks - helping keep you and your family safe and secure.



Every WarmCore door is independently certified to PAS24:2012, the benchmark in enhanced security performance requirements for doorsets and windows in the UK.

Secured by Design



Police Preferred Specification

For added peace of mind choose the optional laminate glass upgrade – giving WarmCore doors Secured by Design accreditation - the official UK Police initiative 'designing out crime' through physical security.

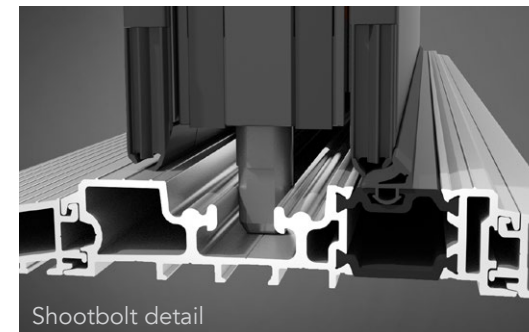

KEEPING YOU AND YOUR HOME SAFE

.....



Five Star Guarantee

With hardware developed in partnership with one of the UK's leading home security manufacturers - ERA - WarmCore doors are covered by the comprehensive ERA Five Star Guarantee. Providing exceptional security and peace of mind.

★ 24/7 help when you need it

The ERA Five Star Guarantee gives access to a FREE call out service so you have the reassurance of knowing that, in the unlikely event of a forced entry, a trained professional will come to secure your property.

★ Up to £1,000 home insurance excess paid

ERA are so confident in the quality, reliability and security of the WarmCore door, they will even pay the excess on any home insurance claim due to the failure of an approved component - so you can be rest assured that you're covered.

★ Up to £1,000 towards a repair or replacement

ERA's research and development team are so confident that WarmCore will outwit any would-be burglars that if the ERA Five Star Guarantee approved component has failed, ERA will pay up to £1,000 towards the cost of replacing or repairing your doors.

★ A £1,000 cheque to compensate you

In the unlikely event of a break-in succeeding through the failure of a component covered by the ERA Five Star Guarantee, you will be given a cheque for £1,000 to compensate you for the inconvenience caused.

★ Savings on the cost of your home insurance

By choosing to fit WarmCore with the highest levels of security, you can save money on your home insurance, year after year.

*Full T&C's of ERA's Five Star Guarantee available separately.

10 YEAR COMPREHENSIVE GUARANTEE AS STANDARD

From the anodised finish of the hardware - suitable for coastal use - to the 60-80 micron powder coat finish on the aluminium (marine grade is 40 microns thick), WarmCore folding sliding doors have been designed to stand the test of time. All fixings used are stainless steel - chosen to resist corrosion - and tough extruded aluminium hinges, along with the quad-wheeled track rollers are precision engineered to perform consistently every single time, year on year.

In keeping with this attention to quality, WarmCore doors carry a comprehensive 10 year guarantee - covering materials, surface finish and operation. So you can feel confident in your decision to add WarmCore folding sliding doors to your home.

*Full T&C's available separately.



PEACE OF MIND - GUARANTEED

.....

A modern kitchen and dining area. The kitchen features light-colored cabinetry, a white countertop, and a wooden island with a bar stool. A large black pendant light hangs over the island. The dining table is set with white plates, glasses, and napkins, and is decorated with several large white hydrangea flowers in clear glass vases. The overall aesthetic is clean and contemporary.

WARMCORE - CREATING SPACES THAT BREATHE



STYLE OPTIONS

Whatever the style of your home, WarmCore folding sliding doors have the options that enable you to create the door that matches your needs.

Available in a choice of 4 hard-wearing powder coated finishes, WarmCore's unique composite construction enables you to choose a different colour for the interior of your door from the outside, at no extra cost.

There is also a choice of 4 external aluminium designs for the door sashes, 4 threshold options and a choice of 3 handle finishes, Matt Black, Brushed Graphite and Satin Silver.

The following pages detail the options available, to help you build your perfect door.



YOUR DOOR, YOUR WAY







WARMCORE - WHEN YOU'RE NOT READY TO SHUT OUT A WONDERFUL DAY



CHOOSE A DIFFERENT COLOUR INSIDE AND OUT - AT NO EXTRA COST

Available in a choice of 4 powder coated colours, WarmCore allows you to pick a different colour for each side of your door - at no extra cost.

From contemporary Anthracite Grey to Heritage Cream, your choice helps define the personality of your door and helps match the architectural style of your home. Want grey outside with white inside to leave you free to change your interior in the future? – with WarmCore that's no problem.

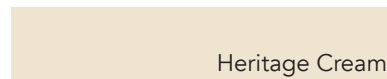

COLOUR - YOUR CHOICE INSIDE AND OUT

.....

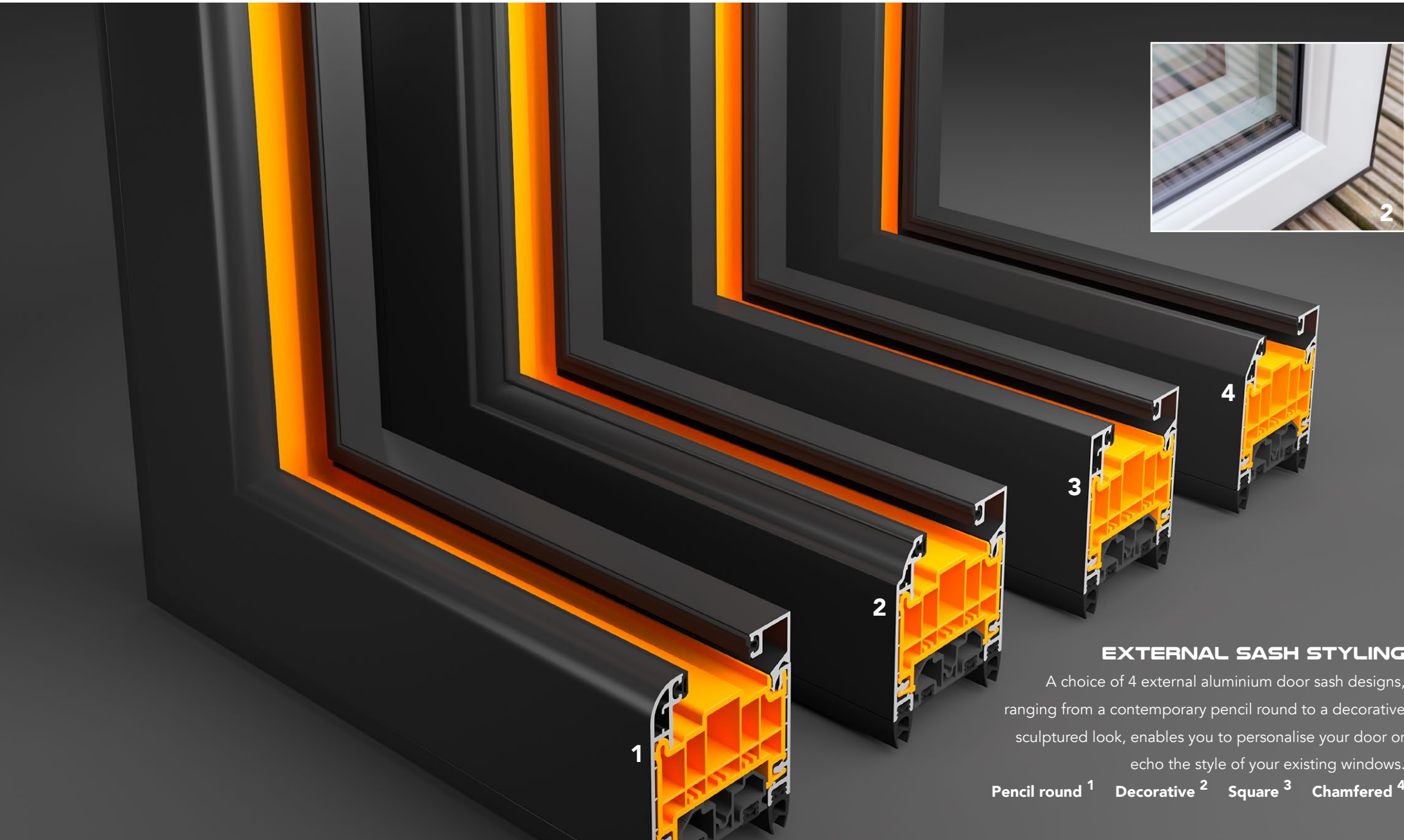

EXTERNAL SASH STYLING

A choice of 4 external aluminium door sash designs, ranging from a contemporary pencil round to a decorative sculptured look, enables you to personalise your door or echo the style of your existing windows.

Pencil round ¹ Decorative ² Square ³ Chamfered ⁴



Matt Black



Satin Silver



Brushed Graphite



GRACEFUL HANDLES...

WarmCore door handles gracefully curve around door sashes when open, tucking into the glass reveal and allowing the door sashes to fold perfectly flat.

...IN 3 FINISHES...

Available in 3 hard-wearing finishes, anodised Matt Black and Satin Silver or Brushed Graphite, choose the perfect match to complement your door.

...BUILT TO LAST

Made to the same exacting standards as the rest of the WarmCore door, the anodised finishes are ideal for use in coastal or exposed locations.

VERSATILITY THROUGH CHOICE



SINGLE & FRENCH DOORS COMPLETE THE RANGE

The WarmCore system is also available as single or French doors, ideal for keeping a consistent look with a larger set of WarmCore doors.

Built to the same exacting standards as the larger doors, this range gives you all the benefits of Warm Aluminium, at a more modest size.

Openings that are 2 door sashes wide can still be specified as folding sliding if you prefer, with the door sashes folding to the left or right as required. With WarmCore it's your choice.



FROM 1 TO 7 SASHES WIDE

.....

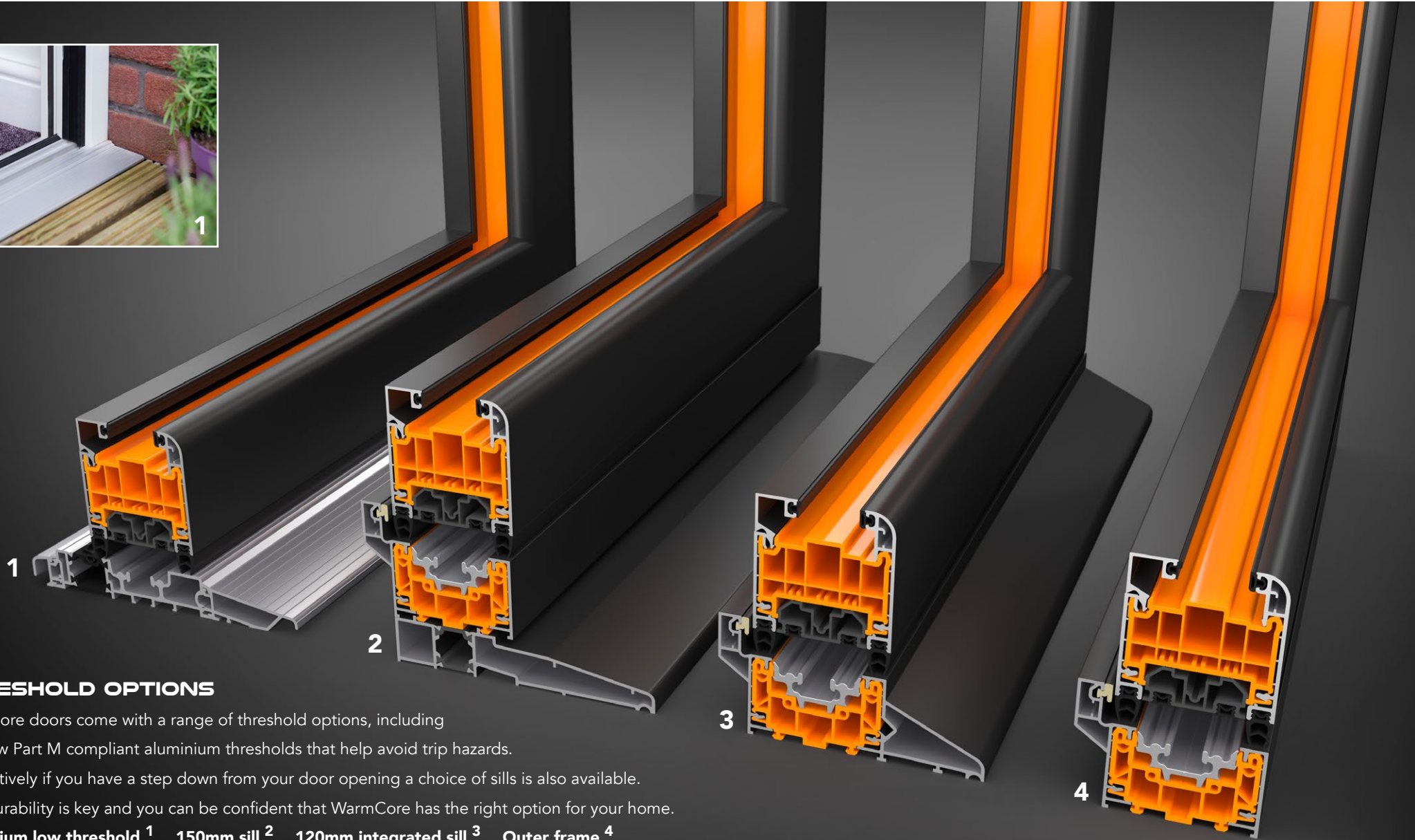

THRESHOLD OPTIONS

WarmCore doors come with a range of threshold options, including ultra low Part M compliant aluminium thresholds that help avoid trip hazards.

Alternatively if you have a step down from your door opening a choice of sills is also available.

Configurability is key and you can be confident that WarmCore has the right option for your home.

Aluminium low threshold ¹ 150mm sill ² 120mm integrated sill ³ Outer frame ⁴

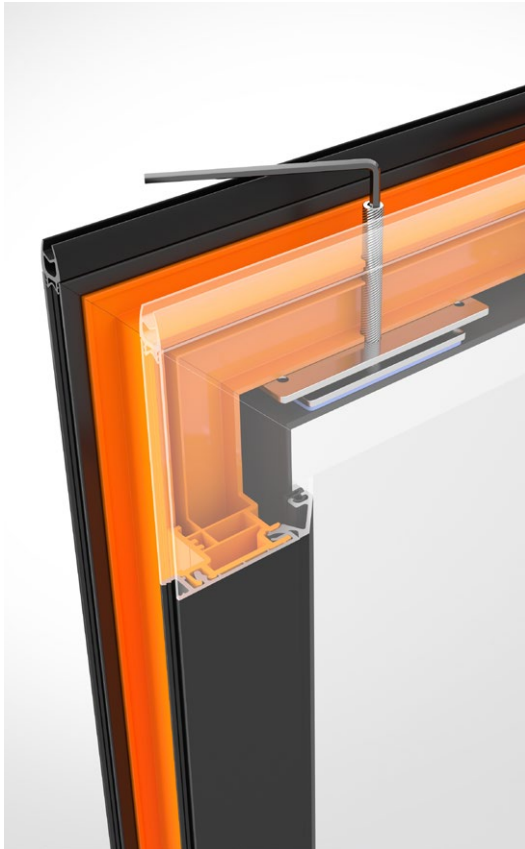

INNOVATIVE DESIGN

With features such as our inbuilt glass adjustment device, WarmCore doors are designed to operate smoothly and have a high degree of adjustment built-in.



NEAT STACKING

Meticulous design and discreet magnets ensure open door sashes run in parallel and stop door sashes 'clattering' when in the open position.



PRECISION COMPONENTS

From the sturdy quad-wheeled rollers, to the multiple weather-seals, every element of your door is precisely manufactured and installed to exacting standards.

BETTER BY DESIGN



TRIPLE GLAZING - FOR ULTIMATE THERMAL PERFORMANCE

Robustly designed to take the weight of triple glazed units as standard, choose this option for the ultimate thermal performance - at least 75% better than standard double glazed aluminium folding sliding doors.

Opting for 44mm triple glazing rather than standard 28mm double glazing reduces the whole door U-Value rating from 1.4 to 1.0. Triple glazing is ideal for WarmCore doors installed in exposed locations.

+75%

better thermal performance than
standard double glazed aluminium
folding sliding doors.



THERMAL PERFORMANCE UPGRADE

.....

CELSIUS Clear™

PERFORMANCE GLASS

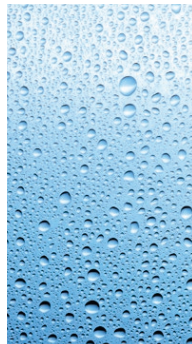
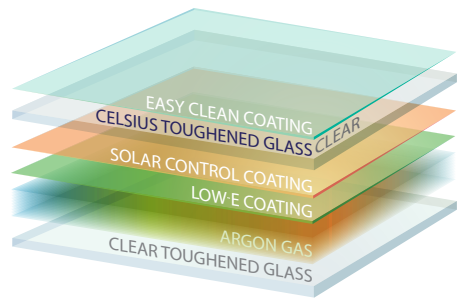

Normal glass



Easy Clean glass

HIGH PERFORMANCE, EASY CLEAN GLASS

Celsius Clear insulated glass is available as an optional upgrade on WarmCore folding sliding doors. This unique high performance glass utilises a Low-E and solar control coating, with an Argon filled cavity, to limit the amount of UV and heat that passes through the glazed unit, giving the ultimate in thermal control, whatever the weather.

KEEPS YOU WARM IN WINTER, AND COOL IN SUMMER

Easy Clean technology has also been added to reduce maintenance requirements. Utilising a coating that lasts the lifetime of the glass, dirt and grime simply washes off with normal rain, rather than sticking to the glass.

heat reflection

58%

UV protection

73%

PERFORMANCE GLASS UPGRADE

PRECISION ENGINEERING

From the sturdy quad-wheeled rollers, to the multiple weather-seals, every element of your door is precisely manufactured and installed to exacting standards. Performance, reliability and ease of use comes from a meticulous attention to detail.

Custom high-strength rollers with a 200kg load capacity are at the heart of ensuring the smooth operation of your WarmCore door. Tested to over 50,000 cycles, these precision components ensure years of trouble-free, reliable operation.

TECHNICAL DATA

.....

Max door width: 6000mm
Max door height: 2400mm
Max sash width: 1000mm
Max load per sash: 100kg
Frame and sash sightline: 129mm
Low threshold and sash sightline: 109mm
Sash to sash sightline: 156mm

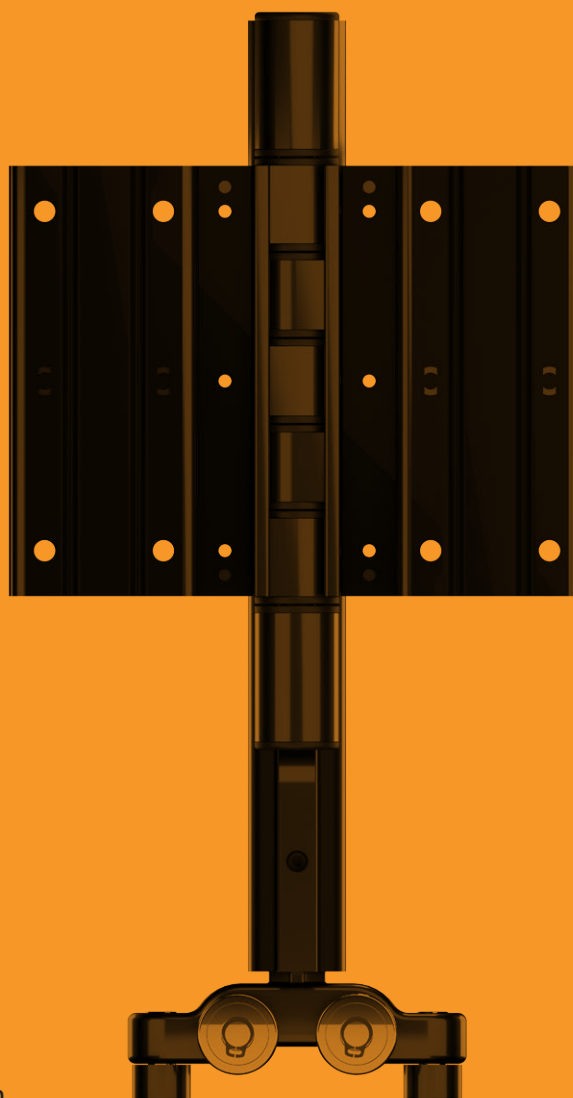

Hinged double pivot roller

WEATHER PERFORMANCE

Triple weather-sealing on all sash interlocks ensures exceptional weather performance, keeping draughts and wind driven rain outside, and you and your family warm and snug. Run-through rubber gaskets create continuous weather-seals helping WarmCore to comfortably exceed the requirements of BS6375-1: the classification for weather tightness on windows and doors.



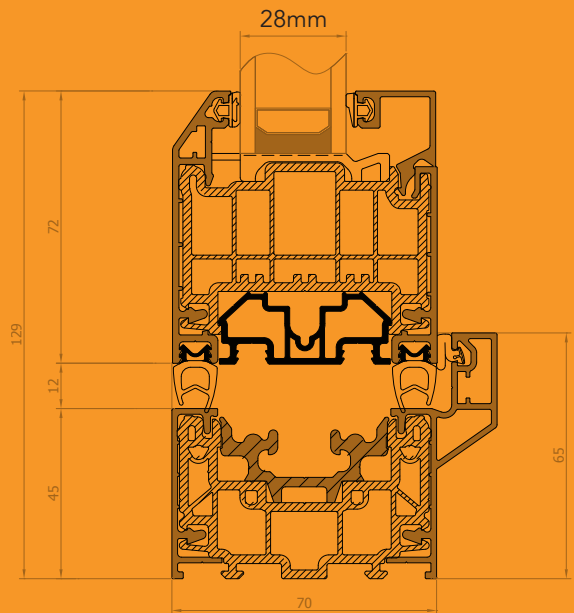

Chamfered sash on outer frame threshold

**CROSS SECTIONS
SHOWING DIFFERENT
WARMCORE
CONFIGURATIONS**

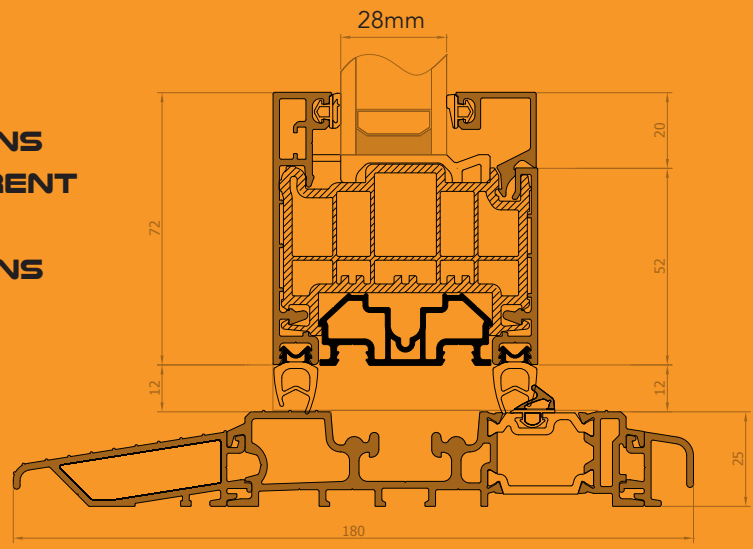

Square sash on Part M compliant low threshold

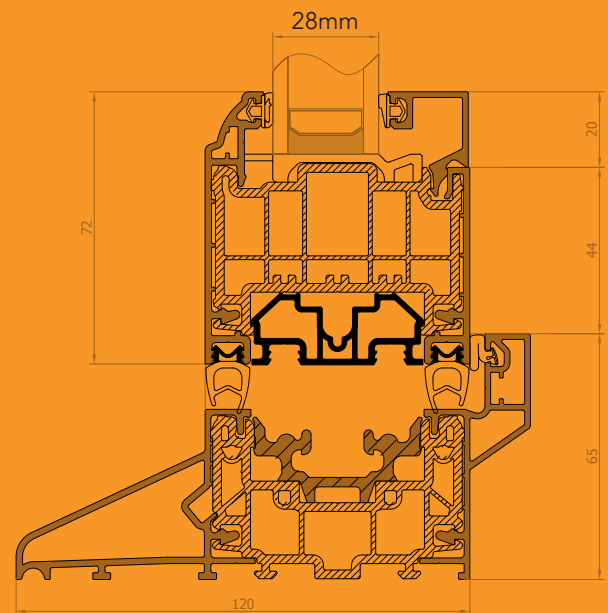

Decorative sash on 120mm integrated sill

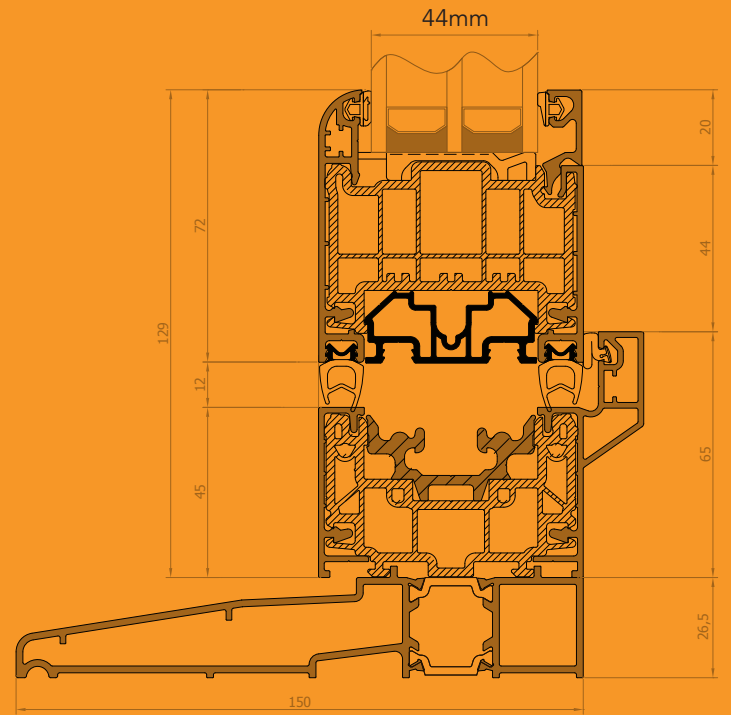

Pencil round sash on 150mm sill with triple glazing

SUMMARY OF WARMCORE OPTIONS

DOOR COLOURS

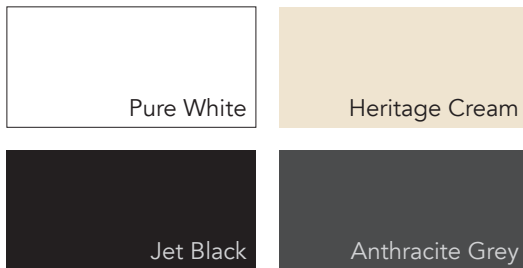

SASH OPTIONS

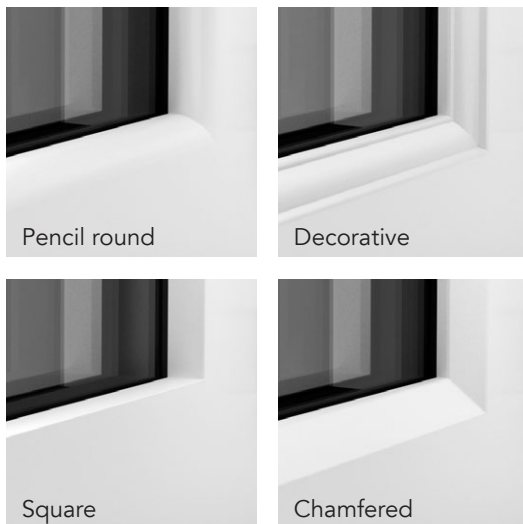

Please note, the colours and finishes shown in this brochure are as close as the printing process allows. Product specification may be subject to change without notification as part of product improvement.

HANDLE FINISHES

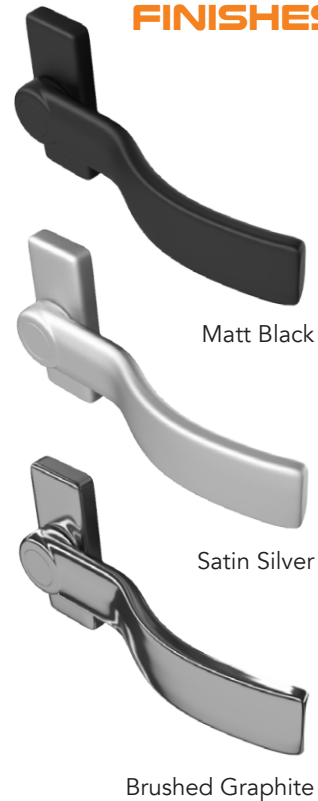

DOOR CONFIGURATIONS

WarmCore doors are described as a set of 3 numbers - the 1st is the total number of door sashes, the 2nd refers to the number of door sashes that open left and the 3rd the number that open right (when viewed from the outside).

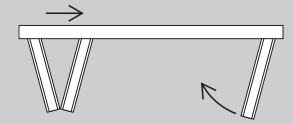

321 style shown from above

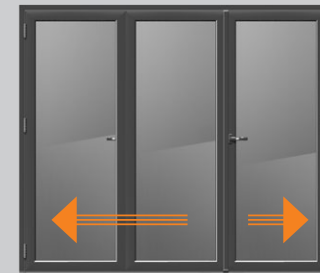

3/2/1



French door



4/2/2



Single door with midrail



7/4/3



ZMWC/RETAILBROCHUREv1

warmcore[®]
FOLDING SLIDING DOORS

**REDEFINING THERMAL
PERFORMANCE IN WIDE SPAN
ALUMINIUM DOORS**

.....

**10 YEAR COMPREHENSIVE
GUARANTEE AS STANDARD**

ERA
★★★★★
Five Star Guarantee

UK designed and
manufactured